

SPECIFICATION OF THERMOELECTRIC MODULE Frost-72

Thermoelectrical parameters	Unit	Value
I_{max}	Amps	6.2
U_{max}	Volts	16.3
ΔT_{max}	K	72
Q_{max}	Watts	62.0
R_{ac} (at 295 K)	Ohm	2.05
Tolerance	%	±10
<i>All parameters except R_{ac} are given at Th=300 K</i>		

Assembly parameters	Unit	Value
Wires	HB-0.35 4 600	
Cross section	mm²	0.35
Metallization	Not	
Sealing	Not	
Internal solder	°C	139
Brazing solder	°C	not

Operational parameters	Unit	Value
Working temperature range	°C	-50 ÷ +80
Max. processing temperature	°C	130
ROHS compliance		YES

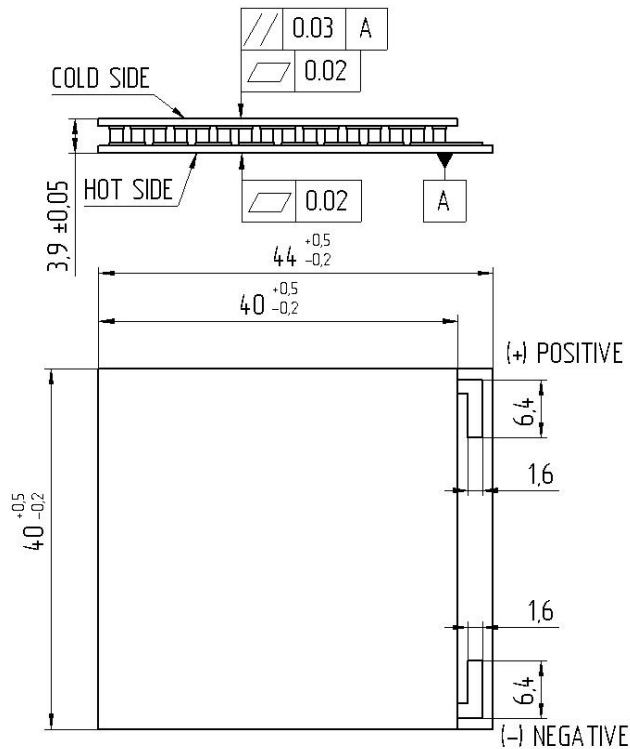
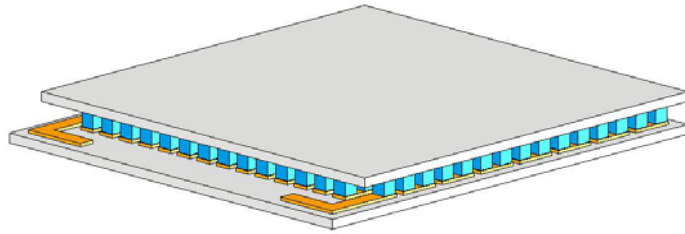