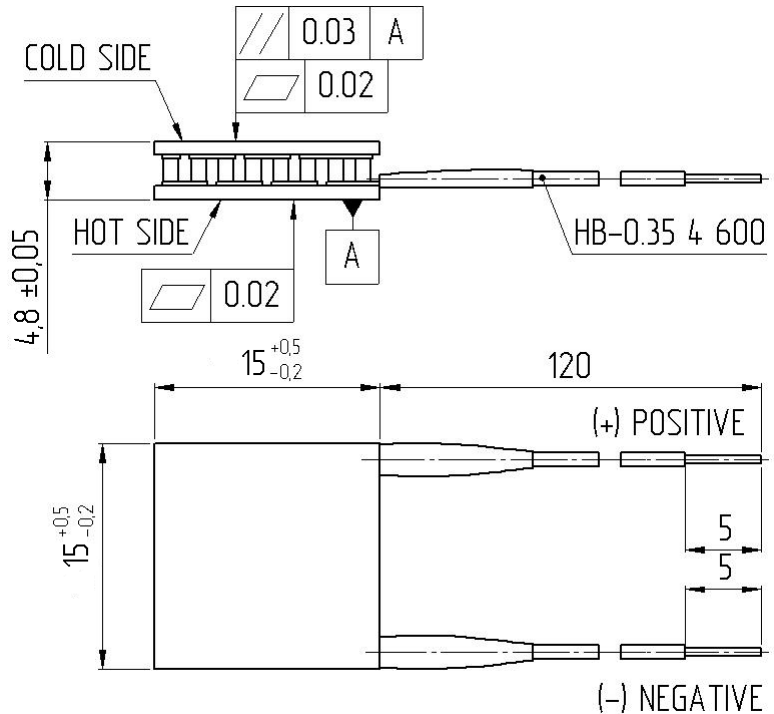
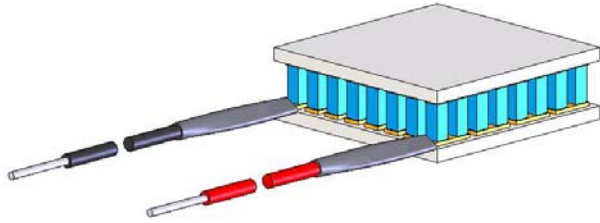

SPECIFICATION OF THERMOELECTRIC MODULE TB-31-1.0-2.5

Thermoelectrical parameters	Unit	Value
I_{max}	Amps	1.9
U_{max}	Volts	3.9
ΔT_{max}	K	70
Q_{max}	Watts	4.5
R_{ac} (at 295 K)	Ohm	1.5
Tolerance	%	±10

All parameters except R_{ac} are given at Th=300 K

Assembly parameters	Unit	Value
Wires	HB-0.35 4 600	
Cross section	mm ²	0.35
Metallization	Not	
Sealing	Not	
Internal solder	°C	139
Brazing solder	°C	not

Operational parameters	Unit	Value
Working temperature range	°C	-50 ÷ +80
Max. processing temperature	°C	130
ROHS compliance		YES

